

Throughout this manual, there are a number of HAZARD WARNINGS that must be read and adhered to in order to prevent possible personal injury and/or damage to equipment. Two signal words "WARNING" and "CAUTION" are used to indicate the severity of a hazard and are preceded by the safety alert symbol.

 **WARNING**

Used when serious injury or death MAY result from misuse or failure to follow specific instructions.

 **CAUTION**



Used when minor or moderate injury or product / equipment damage MAY result from misuse or failure to follow specific instructions.

NOTICE

Indicates information considered important, but not hazard-related.

SAFETY INSTRUCTIONS

Indicates specific safety-related instructions or procedures.

It is the responsibility of all personnel involved in installation, operation and maintenance to fully understand the  Warning and  Caution procedures by which hazards are to be avoided.

Models

LUD, LUB, LUBMO, LUBSH

Twin City Fan & Blower Catalog 4870 provides additional information on this equipment. This catalog can be found at www.tcf.com or by contacting your local Twin City Fan & Blower sales representative.



LUB



LUBMO

Receiving, Unpacking & Inspection

When the equipment is received all items should be carefully checked against the bill of lading to be sure all crates and cartons have been received. Before accepting delivery, carefully inspect each carton or crate for visible shipping damage. If any damage is noticed, the carrier should make the proper notation on the delivery receipt acknowledging the damage. Make notations of all damage on all copies of the bill of lading and have all copies countersigned by the delivering carrier. The carrier should also fill out a Carrier Inspection Report. The factory Traffic Department should then be contacted. File claim for damage with the carrier. Physical damage to the unit after acceptance is not the responsibility of Twin City Fan Companies, Ltd.

Unpack each carton or crate and verify that all required parts and proper quantities of each item have been received. Refer to drawings for part descriptions. Report shortages or missing items to your local representative to arrange for replacement parts.

Due to availability of carriers and truck space, it is not possible to guarantee that all items will be shipped together. Verification of shipments must be limited to only those items on the bill of lading.

NOTICE
The unit nameplate must be checked to make sure the voltage agrees with the power supply available.

 CAUTION
Sheet metal parts, screws, clips and similar items inherently have sharp edges, and it is necessary that the installer and service personnel exercise caution.

The installation of this equipment shall be in accordance with the regulations of authorities having jurisdiction and all applicable codes. This equipment is to be installed by an experienced installation company and fully trained personnel. The mechanical installation of the exhaust ventilator consists of making final connections between the unit and building services, duct connections.

Storage

If fans are stored for any length of time, they should be stored in a clean, dry location to prevent rust and corrosion. Outdoor storage is not recommended. When outdoor storage is necessary, fans should be protected from the elements as completely as possible. Cover the fan inlet and outlet and keep motors dry and clean.

For extended storage (more than 3 months) motor shafts and bearings should be rotated monthly. If stored longer

than 6 months, bearing grease in motor and fan should be purged and replaced with compatible grease. Belts should be rechecked for proper tension. Storage records should be kept to assure proper maintenance. The factory can advise warranty centers to provide motor and bearing service if needed.

Limitation of Warranties and Claims

Seller warrants to the original purchaser that the goods sold hereunder shall be free from defects in workmanship and material under normal use and service (except in those cases where the materials are supplied by the buyer) for a period of one year from the date of original installation or eighteen (18) months from the date of shipment, whichever occurs first. The liability of seller under this warranty is limited to replacing, repairing or issuing credit (at cost, F.O.B. factory and at seller's discretion) for any part or parts which are returned by buyer during such period provided that:

- seller is notified in writing within ten (10) days following discovery of such defects by buyer, or within ten (10) days after such defects should reasonably have been discovered, whichever is less;
- the defective unit is returned to seller, transportation charges prepaid by buyer;
- payment in full has been received by seller for said products;
- seller's examination of such unit shall disclose to its satisfaction that such defects have not been caused by misuse, neglect, improper installation, repair, alteration, act of God or accident.

No warranty made hereunder shall extend to any seller product whose serial number is altered, effaced or removed. Seller makes no warranty, express or implied, with respect to motors, switches, controls or other components of seller's product, where such components are warranted separately by their respective manufacturers. THIS WARRANTY IS EXPRESSLY IN LIEU OF ALL OTHER WARRANTIES, EXPRESS OR IMPLIED, WHETHER STATUTORY OR OTHERWISE, INCLUDING ANY IMPLIED WARRANTY OF MERCHANTABILITY OR FITNESS FOR A PARTICULAR PURPOSE. In no event shall seller be liable to buyer for indirect, incidental collateral or consequential damages of any kind. (BUYER'S FAILURE TO PAY THE FULL AMOUNT DUE WITHIN SIXTY (60) DAYS OF DATE OF INVOICE SHALL OPERATE TO RELEASE SELLER FROM ANY AND ALL LIABILITY OR OBLIGATION ARISING PURSUANT TO ANY WARRANTY, EXPRESS OR IMPLIED, WHETHER STATUTORY OR OTHERWISE, INCLUDING ANY IMPLIED WARRANTY OR MERCHANTABILITY OR FITNESS FOR A PARTICULAR PURPOSE, MADE IN CONNECTION WITH ANY CONTRACT FORMED HEREUNDER. BUYER AGREES THAT SUCH FAILURE TO PAY SHALL CONSTITUTE A VOLUNTARY WAIVER OF ANY AND ALL SUCH WARRANTIES ARISING PURSUANT TO SUCH CONTACT.)

Installation

Models LUD, LUB, LUBMO and LUBSH are all designed to be lifted onto the building by using the windband brackets which double as lifting points for these models. Units can be lifted onto the building with or without the windband mounted onto the unit. Straps or chain capable of handling the load of the unit should be securely attached to each of the four windband brackets.

Once the fan has been carefully lifted onto the roof curb, it should be secured by installing fasteners into all of the holes provided in the base of the fan.

NOTICE

The unit should not be lifted by any other parts such as drive frame, motor, damper blades, windband orifice panel, curb cap, etc.



WARNING

Units with the fusible link assembly are under extremely high spring tension. Care must be taken to not accidentally set off the damper lifters when servicing the fan. The fusible link damper lifters are located under the butterfly damper blades. Failure to exercise caution could cause severe injury or death.

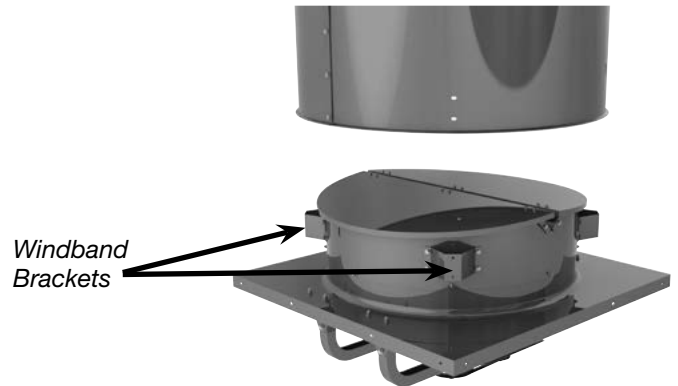

Accessibility

Models LUBMO and LUBSH provide for easy access to the drive parts from the roof. The motor cover is easily removable to provide access to the motor, belt and motor sheave while the standard access panel, located opposite of the motor, provides access to the fan sheave and bearings. Service of the impeller can be achieved by removing the stack cap and orifice panel assemblies from the base.

Motor and drive assemblies on models LUB and LUD can be accessed from the roof by removing the stack cap and orifice panel assemblies from the roof curb. A hinged base is available as an accessory on sizes 36 and below to allow for easier access from the roof.

NOTICE

Twin City Fan recommends the use of an inlet safety guard on all non-ducted installations.

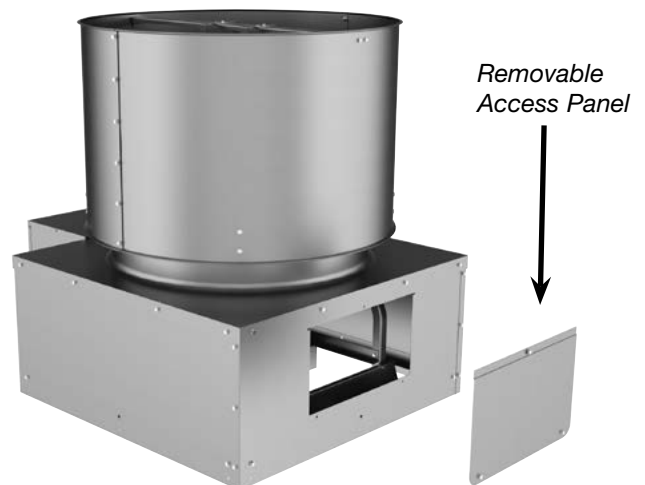
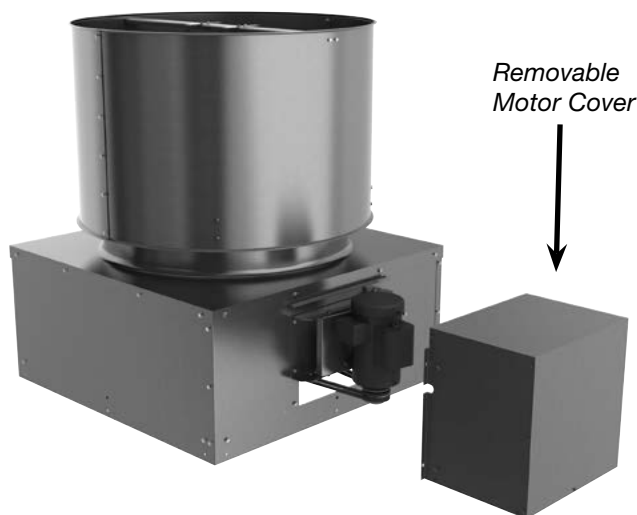

Electrical Connection

1. Connect supply wiring to a disconnect switch. Check the wiring diagrams on the motor for connections.
2. The motor is factory set at the voltage marked on the fan nameplate. Check the line voltage with the nameplate voltage and wiring diagrams.
3. The main power wiring should be sized for the ampacity shown on the dataplate. Size wires in accordance with the ampacity tables in Article 310 of the National Electrical Code. If long wires are required, it may be necessary to increase wire size to prevent excessive voltage drop. Wires should be sized for a maximum of 3% voltage drop.

 CAUTION
Use copper conductors only.
Protect wiring from sharp edges. Leave some slack in the line to prevent damage.

4. (Optional) Disconnect switches are not fused. The **power leads must be protected** at the point of distribution in accordance with the fan dataplate.

5. On fans without a thermal protector integral to the motor (refer to unit or motor dataplate to determine if protector is present) a separate overload device is required. Refer to Sections 430-32 of the N.E.C. for sizing.
6. All units must be electrically grounded in accordance with local codes or, in the absence of local codes, with the latest edition of the National Electrical Code (ANSI/NFPA 70). A ground lug is provided as standard in the unit terminal box. Size grounding conductor in accordance with Table 250-95 of the National Electrical Code. **DO NOT** use the ground lug for connecting a neutral conductor.
7. Supply voltage to the power ventilator should not vary by more than 10% of the value indicated on the unit dataplate. Phase unbalance must not exceed 2%.

 WARNING
Failure of motor due to operation on improper line voltage or with excessive phase unbalance constitutes product abuse and may cause severe damage to the unit's electrical components.

Check, Test & Start Procedure

 WARNING
Electric shock hazard. Could cause severe injury or death. Failure to bond the frame of this equipment to the building electrical ground by use of the grounding terminal provided or other acceptable means may result in electrical shock. Disconnect electric power before servicing equipment. Service to be performed only by qualified personnel.

 WARNING
Check units for rotation. For three-phase, rotation can be changed by interchanging any two of the three line leads. If unit is checked on temporary wiring, it should be rechecked when permanently installed. Motor burn-out or tripped overload protection devices are usually the result of wrong rotation.

SAFETY INSTRUCTIONS
BEFORE START-UP: Disconnect power to this unit before servicing the unit.

1. Check to verify that the impeller is free to rotate.
2. Verify that supply voltage on the line side of disconnect agrees with voltage on fan data plate and is within the 10% utilization voltage.
3. Apply power to unit and check rotation of impeller with the directional arrow on the unit.

4. **Electrical Input Check:** Perform check of fan ampere draw and verify that motor nameplate amps are not exceeded. Take into account the service factor range if motor is nameplated above a 1.0 service factor.
5. Fan RPM should be checked and verified with a tachometer.

 WARNING
Rotation is critical. If allowed to operate in the wrong direction, the motor will overload and burn out.

NOTICE
The fan was balanced at the factory to be within stringent vibration levels before shipment. However, there are several things that may cause vibration, such as rough handling in shipment and installation, weak foundations and alignments.

Maintenance

Installation and maintenance are to be performed only by qualified personnel who are familiar with local codes and regulations and experienced with this type of equipment.

CAUTION

Sharp edges and screws are a potential injury hazard. Avoid them.

WARNING

Hazardous moving parts. Unit may contain protected fan motor which may start automatically and cause injury. Allow time for reset. **Disconnect power before servicing.**

Preventive maintenance is the best way to avoid unnecessary expense and inconvenience. Start-up and routine maintenance should cover the following items:

- a. Tighten all setscrews, bolts and wire connections.
- b. Check belt tension and sheaves for wear.
- c. Lubricate fan bearings (see Tables 1 and 2).
- d. Cleaning of unit, impeller and damper (if present).

All motors containing ball bearings are permanently lubricated from the factory. No additional maintenance is required.

1. Before performing any maintenance on the fan, be sure power is turned off and locked in the OFF position at the service entrance.
2. Ventilators should be carefully checked at least once a year. For critical or rugged applications, a routine check every two or three months is suggested.
3. For repairs within the warranty period, the motor must be taken to the motor manufacturer's authorized service dealer.
4. A periodic motor check should consist of spinning the motor shaft with the power off to be sure the motor turns freely and the bearings run smoothly. The belt on belt driven units should be removed from the motor sheave.
5. When removing or installing a belt, do not force the belt over the sheave. Loosen the motor mount so that the belt can be easily slipped over the sheave. (For Notes 5-9, refer to page 7.)
6. The belt on belt driven units should be removed and carefully checked for glazing, cracks, ply separation or irregular wear. A small irregularity in the contact surface of the belt will result in noisy operation. If any of these defects are apparent, the belt should be replaced. Check the sheaves also for chipping, dents or rough surfaces which could damage the belt.
7. The correct belt tension is important. Too tight of a belt will result in excess bearing pressure on the motor bearings and shaft pillow blocks and may also overload the motor. Too loose of a belt will

result in slippage which will quickly "burn" out belts. A belt should feel "live" when thumped, approximately 1/4" belt deflection (3 to 5 lb.) when subject to finger pressure at midpoint between sheaves.

8. The belt alignment should also be checked to be sure the belt is running perpendicularly to the rotating shafts. Fan and motor shafts must be parallel. Improper alignment will result in excessive belt wear.
9. Check sheave setscrews to ensure tightness. Proper keys must be in keyways.
10. For blade angle adjustments on Type 'E' Impellers (Level 3), refer to Engineering Supplement ES-404.
11. If unit is to be left idle for an extended period, it is recommended that belts be removed and stored in a cool, dry place to avoid premature belt failure.
12. The standard pillow block bearings on belt driven ventilators are factory lubricated and are provided with external grease fittings. Annual lubrication is recommended, or more frequently if needed (see Table 1).

It is recommended to add fresh grease at start-up. Use only 2 or 3 shots of a recommended lubricant with a hand gun in most cases (see Table 2). Maximum hand gun rating 40 P.S.I. Rotate bearings during lubrication where good safety practice permits.

CAUTION

Greases of different soap bases (lithium, sodium, etc.) may not be compatible when mixed. Prevent such intermixing by completely purging the bearing of old greases.

The most frequent causes of bearing failure are not greasing often enough, using an excessive quantity of grease or using incompatible greases. Excessive vibration, especially if the bearing is not rotating, will also cause bearings to fail. Bearings must also be protected from water and moisture to avoid internal corrosion.

Table 1. Suggested Fan Bearing Greasing Intervals

INTERVAL (MONTHS)	TYPE OF SERVICE
12 to 18	Infrequent operation or light duty in clean atmosphere
6 to 12	8 to 16 hrs./day in clean, relatively dry atmosphere
3 to 6	12 to 24 hrs./day, heavy-duty or if moisture is present
1 to 3	Heavy-duty in dirty, dusty locations; high ambient temperatures; moisture-laden atmosphere; vibration

Table 2. Grease Manufacturers

MANUFACTURER	GREASE (NLGI #2)
Shell	Gadus S2 V100 2
Exxon/Mobil	Ronex MP

13. During the first few months of operation it is recommended that the bearing setscrews be checked periodically to ensure that they are tight.
14. The rotating impeller requires particular attention since materials in the air being handled can build up on the blades to cause destructive vibration or weaken the structure of the impeller by corroding and/or eroding the blade metal. Regular inspection and corrective action at intervals determined by the severity of each application are essential to good service life and safety.
15. **Filter Maintenance (Filtered Supply Fans)**
Inspect the 2" Aluminum Mesh Filters on a regular basis. Clogged filters can adversely affect air performance.

On all fan sizes the filters can be removed with the hood in place by removing the filter retainers from the hood end panels and sliding them out of the filter rails. On sizes 21-30 it is recommended to remove the 1½" bolts connecting the hood side rails to the hood mount bars on the fan housing on one side and loosen the ones on the opposite side and tilt the hood back to gain access. Wash filters with a mild detergent in warm water.

Bearing Replacement

Fan bearings on belt driven fans should not need to be replaced for many years if the previous recommendations are strictly adhered to. However, use the following procedure when bearing replacement is necessary.

1. Gain access to the fan bearings. Remove the bearing cover, if any.
2. Loosen the belts by shifting the motor.
3. Remove the impeller and disconnect the remote lubrication tubes (if applicable).
4. Measure the location of the bearing to the impeller end of the shaft and the bearing spacing.
5. Remove the shaft and bearing assembly. Note the position of the bearings' shims (if applicable).
6. Loosen all bearing/shaft setscrews or other locking devices.
7. Remove bearings (may need to be pressed off the shaft).
8. Polish the shaft with fine emery paper (240 grit or finer) and file the setscrew dimples left on the shaft flat.
9. Install new bearings on the shaft, making sure that the collars are together (i.e. facing each other on the shaft). Lightly seat one setscrew or eccentric locking collar on each bearing to hold in the approximate marked position.
10. Mount the shaft/bearing assembly in the fan with bolts. Do not tighten yet. Just snug up. Loosen the setscrew.
11. Center the shaft in the housing (both ends) as closely as possible. (The fan impeller may need to be temporarily installed to get its clearances equal.)
12. Lubricate bearings. See Tables 1 and 2, Page 5.
13. Tighten setscrews in steps (alternating half turns). Note torquing requirements with bearing instructions.
14. Tighten the bearing mounting bolts.
15. Reinstall the lube tubes (if applicable).
16. Install impeller and belts and adjust the motor to get proper belt tension. Also, make sure that the sheaves are properly aligned.
17. If a new shaft is supplied, ignore items 6 thru 8.

Motors

Twin City Fan & Blower recommends periodic checks of voltage, frequency and current of a motor while in operation. Such checks assure the correctness of frequency and voltage applied to the motor, and yield an indication of the fan load. Comparison of this data with previous data will give an indication of the fan performance. Any serious deviations could indicate a potential motor failure.

All motors have prelubricated sealed bearings and are lubricated for the life of the motor.

1. All motors carry a limited warranty from the motor manufacturer. For repairs within the warranty period, the motor must be taken to the motor manufacturer's authorized service dealer. Contact your representative for additional warranty details.

2. A periodic motor check should consist of spinning the motor shaft with the power off to be sure the motor turns freely and the bearings run smoothly. The belt on belt driven units should be removed from the motor pulley.

Repair or replacement of motors is normally performed by a repair station authorized by the manufacturer. Contact your representative or the factory for locations nearest you. DO NOT ship motor to the factory without specific authorization forms.

V-Belts

V-belts on these belt driven fans are oil, heat and static resistant type and oversized for continuous-duty. With proper installation and maintenance, years of operating efficiency can be added to the lifespan of the V-belt drive.

The condition of V-belts and the amount of belt tension should be checked prior to start-up (see Figure 1). When it becomes necessary to adjust belt tension, do not over-tension as bearing damage will occur. Recommended belt tension should permit $\frac{1}{64}$ " deflection per inch of span of the belt at the center of the belt span. To find this point, measure halfway between the pulley centerlines as shown in Figure 2. Extreme care must be exercised when adjusting V-belts as not to misalign the pulleys. Any misalignment will cause a sharp reduction in belt life and will also produce squeaky, annoying noises (see Figure 3). On units equipped with 2-groove pulleys, adjustments must be made so that there is equal tension on all belts (see Figure 5).

1. Where tensioning rods are not available, adjustment is more easily obtained by loosening and adjusting one side of the motor bracket at a time.
2. Always loosen tension adjustment enough to place belts on sheaves without running belts over the edge of either sheave. A new belt may be seriously damaged internally by careless handling (see Figure 4).

WARNING

When removing or installing belts, never force belts over pulleys without loosening motor first to relieve belt tension.

3. Fan speed can be increased by closing the adjustable motor pulley or decreased by opening it. Two and three groove adjustable pitch pulleys must be adjusted an equal number of turns. (See Figure 5). Always check load on motor when increasing fan speed.

Figure 1. Eliminate Slack

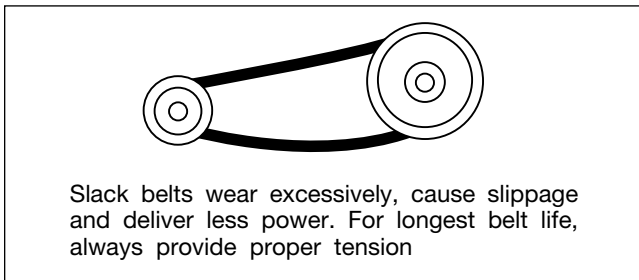

Figure 2. Belt Deflection

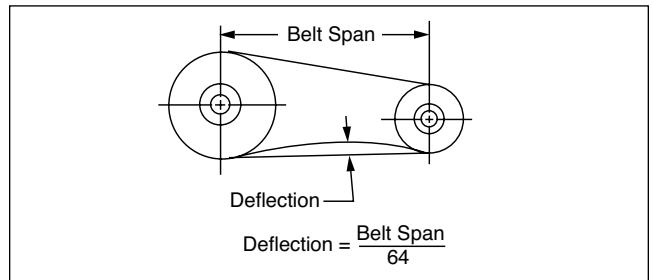
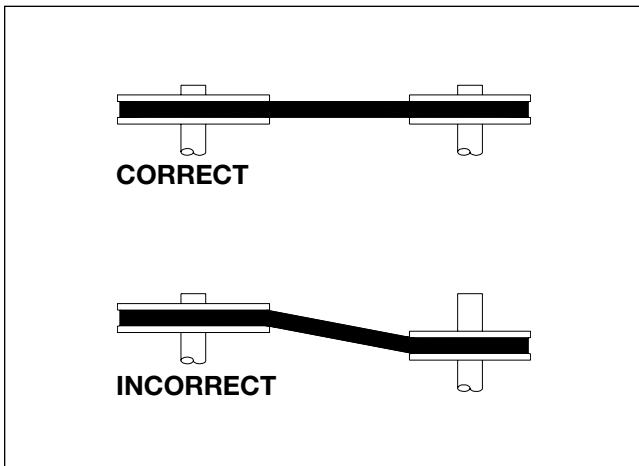

Figure 3. Alignment



Mount belts straight. Shafts must be parallel and sheaves in alignment to prevent unnecessary belt wear.

Figure 4. Belts

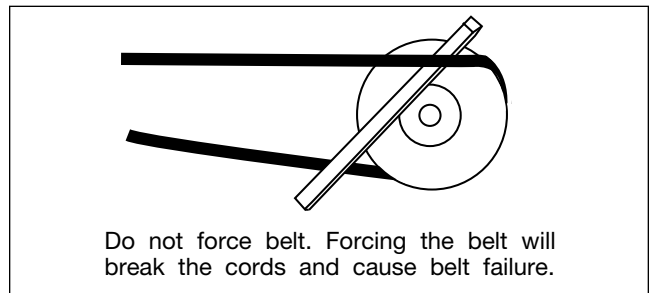
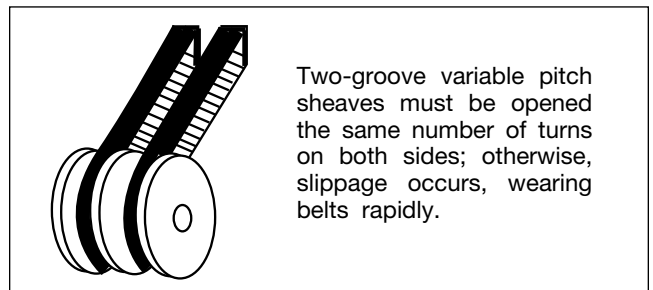

Figure 5. 2-Groove Sheaves



Fan Troubleshooting Chart

PROBLEM	POSSIBLE CAUSES
FAN DOES NOT OPERATE	<ol style="list-style-type: none"> 1. Wrong voltage. 2. Electricity turned off or not wired properly. 3. Tripped overload protector. 4. Blown fuses. 5. Loose pulleys. 6. Broken belts.
TOO LITTLE AIR	<ol style="list-style-type: none"> 1. Impeller rotating in wrong direction. 2. Fan speed lower than design. 3. System is more restrictive (more static pressure) than expected. 4. Restricted fan inlet or outlet. 5. Inlet or outlet screens clogged. 6. Filters, if applicable, are dirty or clogged.
TOO MUCH AIR	<ol style="list-style-type: none"> 1. Fan speed higher than design. 2. System is less restrictive (less static pressure) than expected. 3. Filters, if applicable, not in place.
EXCESSIVE HORSEPOWER	<ol style="list-style-type: none"> 1. Impeller rotating in wrong direction. 2. Impeller rubbing on inlet venturi. 3. Fan speed higher than design. 4. Worn fan bearings.
EXCESSIVE NOISE	<ol style="list-style-type: none"> 1. Impeller or sheaves loose. 2. Bearing or drive misalignment. 3. Accumulation of material on impeller. 4. Worn or corroded impeller. 5. Impeller out of balance. 6. Impeller hitting housing. 7. Bent shaft. 8. Bearings need lubrication. 9. Loose bearing bolts. 10. Loose or worn bearings. 11. Mismatched belts. 12. Belts too loose or too tight. 13. Belts oily or dirty. 14. Belts worn. 15. Loose fan mounting bolts. 16. Rattle of components in high velocity airstream. 17. Vibrating parts not isolated from building. 18. Noise from high velocity air system. 19. Electrical noise. 20. Vibrating ductwork.
EXCESSIVE VIBRATION	<ol style="list-style-type: none"> 1. Impeller or sheaves loose on shaft. 2. Impeller out of balance. 3. Excessive buildup of dirt/dust on impeller. 4. Belts too loose or too tight. 5. Mismatched belts. 6. Bent shaft. 7. Bearing or drive misalignment. 8. Loose or worn bearings. 9. Fan mounting bolts loose. 10. Structures not cross-braced.

It is recommended that the users and installers of this shipment familiarize themselves with AMCA Publication #201, "Fans and Systems" and publication #202, "Troubleshooting" which are published by the Air Movement and Control Association (AMCA), 30 West University Drive, Arlington Heights, Illinois 60004. www.amca.org



TWIN CITY FAN & BLOWER | WWW.TCF.COM

5959 Trenton Lane N | Minneapolis, MN 55442 | Phone: 763-551-7600 | Fax: 763-551-7601